

Column-Stores vs. Row-Stores: How Different Are They Really?

Daniel J. Abadi
Yale University
New Haven, CT, USA
dna@cs.yale.edu

Samuel R. Madden
MIT
Cambridge, MA, USA
madden@csail.mit.edu

Nabil Hachem
AvantGarde Consulting, LLC
Shrewsbury, MA, USA
nhachem@agdba.com

ABSTRACT

There has been a significant amount of excitement and recent work on column-oriented database systems (“column-stores”). These database systems have been shown to perform more than an order of magnitude better than traditional row-oriented database systems (“row-stores”) on analytical workloads such as those found in data warehouses, decision support, and business intelligence applications. The elevator pitch behind this performance difference is straightforward: column-stores are more I/O efficient for read-only queries since they only have to read from disk (or from memory) those attributes accessed by a query.

This simplistic view leads to the assumption that one can obtain the performance benefits of a column-store using a row-store: either by vertically partitioning the schema, or by indexing every column so that columns can be accessed independently. In this paper, we demonstrate that this assumption is false. We compare the performance of a commercial row-store under a variety of different configurations with a column-store and show that the row-store performance is significantly slower on a recently proposed data warehouse benchmark. We then analyze the performance difference and show that there are some important differences between the two systems at the query executor level (in addition to the obvious differences at the storage layer level). Using the column-store, we then tease apart these differences, demonstrating the impact on performance of a variety of column-oriented query execution techniques, including vectorized query processing, compression, and a new join algorithm we introduce in this paper. We conclude that while it is not impossible for a row-store to achieve some of the performance advantages of a column-store, changes must be made to both the storage layer and the query executor to fully obtain the benefits of a column-oriented approach.

Categories and Subject Descriptors

H.2.4 [Database Management]: Systems—*Query processing, Relational databases*

Permission to make digital or hard copies of all or part of this work for personal or classroom use is granted without fee provided that copies are not made or distributed for profit or commercial advantage and that copies bear this notice and the full citation on the first page. To copy otherwise, to republish, to post on servers or to redistribute to lists, requires prior specific permission and/or a fee.

SIGMOD 08, June 9–12, 2008, Vancouver, BC, Canada.
Copyright 2008 ACM 978-1-60558-102-6/08/06 ...\$5.00.

General Terms

Experimentation, Performance, Measurement

Keywords

C-Store, column-store, column-oriented DBMS, invisible join, compression, tuple reconstruction, tuple materialization.

1. INTRODUCTION

Recent years have seen the introduction of a number of column-oriented database systems, including MonetDB [9, 10] and C-Store [22]. The authors of these systems claim that their approach offers order-of-magnitude gains on certain workloads, particularly on read-intensive analytical processing workloads, such as those encountered in data warehouses.

Indeed, papers describing column-oriented database systems usually include performance results showing such gains against traditional, row-oriented databases (either commercial or open source). These evaluations, however, typically benchmark against row-oriented systems that use a “conventional” physical design consisting of a collection of row-oriented tables with a more-or-less one-to-one mapping to the tables in the logical schema. Though such results clearly demonstrate the potential of a column-oriented approach, they leave open a key question: *Are these performance gains due to something fundamental about the way column-oriented DBMSs are internally architected, or would such gains also be possible in a conventional system that used a more column-oriented physical design?*

Often, designers of column-based systems claim there is a fundamental difference between a from-scratch column-store and a row-store using column-oriented physical design without actually exploring alternate physical designs for the row-store system. Hence, one goal of this paper is to answer this question in a systematic way. One of the authors of this paper is a professional DBA specializing in a popular commercial row-oriented database. He has carefully implemented a number of different physical database designs for a recently proposed data warehousing benchmark, the Star Schema Benchmark (SSBM) [18, 19], exploring designs that are as “column-oriented” as possible (in addition to more traditional designs), including:

- Vertically partitioning the tables in the system into a collection of two-column tables consisting of (table key, attribute) pairs, so that only the necessary columns need to be read to answer a query.
- Using index-only plans; by creating a collection of indices that cover all of the columns used in a query, it is possible

for the database system to answer a query without ever going to the underlying (row-oriented) tables.

- Using a collection of materialized views such that there is a view with exactly the columns needed to answer every query in the benchmark. Though this approach uses a lot of space, it is the ‘best case’ for a row-store, and provides a useful point of comparison to a column-store implementation.

We compare the performance of these various techniques to the baseline performance of the open-source C-Store database [22] on the SSBM, showing that, despite the ability of the above methods to emulate the physical structure of a column-store inside a row-store, their query processing performance is quite poor. Hence, one contribution of this work is showing that there is in fact something fundamental about the design of column-store systems that makes them better suited to data-warehousing workloads. This is important because it puts to rest a common claim that it would be easy for existing row-oriented vendors to adopt a column-oriented physical database design. We emphasize that our goal is not to find the fastest performing implementation of SSBM in our row-oriented database, but to evaluate the performance of specific, “columnar” physical implementations, which leads us to a second question: *Which of the many column-database specific optimizations proposed in the literature are most responsible for the significant performance advantage of column-stores over row-stores on warehouse workloads?*

Prior research has suggested that important optimizations specific to column-oriented DBMSs include:

- Late materialization (when combined with the block iteration optimization below, this technique is also known as vectorized query processing [9, 25]), where columns read off disk are joined together into rows as late as possible in a query plan [5].
- Block iteration [25], where multiple values from a column are passed as a block from one operator to the next, rather than using Volcano-style per-tuple iterators [11]. If the values are fixed-width, they are iterated through as an array.
- Column-specific compression techniques, such as run-length encoding, with direct operation on compressed data when using late-materialization plans [4].
- We also propose a new optimization, called *invisible joins*, which substantially improves join performance in late-materialization column stores, especially on the types of schemas found in data warehouses.

However, because each of these techniques was described in a separate research paper, no work has analyzed exactly which of these gains are most significant. Hence, a third contribution of this work is to carefully measure different variants of the C-Store database by removing these column-specific optimizations one-by-one (in effect, making the C-Store query executor behave more like a row-store), breaking down the factors responsible for its good performance. We find that compression can offer order-of-magnitude gains when it is possible, but that the benefits are less substantial in other cases, whereas late materialization offers about a factor of 3 performance gain across the board. Other optimizations – including block iteration and our new invisible join technique, offer about a factor 1.5 performance gain on average.

In summary, we make three contributions in this paper:

1. We show that trying to emulate a column-store in a row-store does not yield good performance results, and that a variety of techniques typically seen as “good” for warehouse performance (index-only plans, bitmap indices, etc.) do little to improve the situation.
2. We propose a new technique for improving join performance in column stores called *invisible joins*. We demonstrate experimentally that, in many cases, the execution of a join using this technique can perform as well as or better than selecting and extracting data from a single denormalized table *where the join has already been materialized*. We thus conclude that denormalization, an important but expensive (in space requirements) and complicated (in deciding in advance what tables to denormalize) performance enhancing technique used in row-stores (especially data warehouses) is not necessary in column-stores (or can be used with greatly reduced cost and complexity).
3. We break-down the sources of column-database performance on warehouse workloads, exploring the contribution of late-materialization, compression, block iteration, and invisible joins on overall system performance. Our results validate previous claims of column-store performance on a new data warehousing benchmark (the SSBM), and demonstrate that simple column-oriented operation – without compression and late materialization – does not dramatically outperform well-optimized row-store designs.

The rest of this paper is organized as follows: we begin by describing prior work on column-oriented databases, including surveying past performance comparisons and describing some of the architectural innovations that have been proposed for column-oriented DBMSs (Section 2); then, we review the SSBM (Section 3). We then describe the physical database design techniques used in our row-oriented system (Section 4), and the physical layout and query execution techniques used by the C-Store system (Section 5). We then present performance comparisons between the two systems, first contrasting our row-oriented designs to the baseline C-Store performance and then decomposing the performance of C-Store to measure which of the techniques it employs for efficient query execution are most effective on the SSBM (Section 6).

2. BACKGROUND AND PRIOR WORK

In this section, we briefly present related efforts to characterize column-store performance relative to traditional row-stores.

Although the idea of vertically partitioning database tables to improve performance has been around a long time [1, 7, 16], the MonetDB [10] and the MonetDB/X100 [9] systems pioneered the design of modern column-oriented database systems and vectorized query execution. They show that column-oriented designs – due to superior CPU and cache performance (in addition to reduced I/O) – can dramatically outperform commercial and open source databases on benchmarks like TPC-H. The MonetDB work does not, however, attempt to evaluate what kind of performance is possible from row-stores using column-oriented techniques, and to the best of our knowledge, their optimizations have never been evaluated in the same context as the C-Store optimization of direct operation on compressed data.

The fractured mirrors approach [21] is another recent column-store system, in which a hybrid row/column approach is proposed. Here, the row-store primarily processes updates and the column-store primarily processes reads, with a background process migrating data from the row-store to the column-store. This work

4. ROW-ORIENTED EXECUTION

In this section, we discuss several different techniques that can be used to implement a column-database design in a commercial row-oriented DBMS (hereafter, System X). We look at three different classes of physical design: a fully vertically partitioned design, an “index only” design, and a materialized view design. In our evaluation, we also compare against a “standard” row-store design with one physical table per relation.

Vertical Partitioning: The most straightforward way to emulate a column-store approach in a row-store is to fully vertically partition each relation [16]. In a fully vertically partitioned approach, some mechanism is needed to connect fields from the same row together (column stores typically match up records implicitly by storing columns in the same order, but such optimizations are not available in a row store). To accomplish this, the simplest approach is to add an integer “position” column to every table – this is often preferable to using the primary key because primary keys can be large and are sometimes composite (as in the case of the line-order table in SSBM). This approach creates one physical table for each column in the logical schema, where the i th table has two columns, one with values from column i of the logical schema and one with the corresponding value in the position column. Queries are then rewritten to perform joins on the position attribute when fetching multiple columns from the same relation. In our implementation, by default, System X chose to use hash joins for this purpose, which proved to be expensive. For that reason, we experimented with adding clustered indices on the position column of every table, and forced System X to use index joins, but this did not improve performance – the additional I/Os incurred by index accesses made them slower than hash joins.

Index-only plans: The vertical partitioning approach has two problems. First, it requires the position attribute to be stored in every column, which wastes space and disk bandwidth. Second, most row-stores store a relatively large header on every tuple, which further wastes space (column stores typically – or perhaps even by definition – store headers in separate columns to avoid these overheads). To ameliorate these concerns, the second approach we consider uses *index-only plans*, where base relations are stored using a standard, row-oriented design, but an additional unclustered B+Tree index is added on every column of every table. Index-only plans – which require special support from the database, but are implemented by System X – work by building lists of (record-id,value) pairs that satisfy predicates on each table, and merging these rid-lists in memory when there are multiple predicates on the same table. When required fields have no predicates, a list of all (record-id,value) pairs from the column can be produced. Such plans never access the actual tuples on disk. Though indices still explicitly store rids, they do not store duplicate column values, and they typically have a lower per-tuple overhead than the vertical partitioning approach since tuple headers are not stored in the index.

One problem with the index-only approach is that if a column has no predicate on it, the index-only approach requires the index to be scanned to extract the needed values, which can be slower than scanning a heap file (as would occur in the vertical partitioning approach.) Hence, an optimization to the index-only approach is to create indices with composite keys, where the secondary keys are from predicate-less columns. For example, consider the query `SELECT AVG(salary) FROM emp WHERE age>40` – if we have a composite index with an (age,salary) key, then we can answer this query directly from this index. If we have separate indices on (age) and (salary), an index only plan will have to find record-ids corresponding to records with satisfying ages and then merge this with the complete list of (record-id, salary) pairs extracted from

the (salary) index, which will be much slower. We use this optimization in our implementation by storing the primary key of each dimension table as a secondary sort attribute on the indices over the attributes of that dimension table. In this way, we can efficiently access the primary key values of the dimension that need to be joined with the fact table.

Materialized Views: The third approach we consider uses materialized views. In this approach, we create an *optimal* set of materialized views for every query flight in the workload, where the optimal view for a given flight has only the columns needed to answer queries in that flight. We do not pre-join columns from different tables in these views. Our objective with this strategy is to allow System X to access just the data it needs from disk, avoiding the overheads of explicitly storing record-id or positions, and storing tuple headers just once per tuple. Hence, we expect it to perform better than the other two approaches, although it does require the query workload to be known in advance, making it practical only in limited situations.

5. COLUMN-ORIENTED EXECUTION

Now that we’ve presented our row-oriented designs, in this section, we review three common optimizations used to improve performance in column-oriented database systems, and introduce the invisible join.

5.1 Compression

Compressing data using column-oriented compression algorithms and keeping data in this compressed format as it is operated upon has been shown to improve query performance by up to an order of magnitude [4]. Intuitively, data stored in columns is more compressible than data stored in rows. Compression algorithms perform better on data with low *information entropy* (high data value locality). Take, for example, a database table containing information about customers (name, phone number, e-mail address, snail-mail address, etc.). Storing data in columns allows all of the names to be stored together, all of the phone numbers together, etc. Certainly phone numbers are more similar to each other than surrounding text fields like e-mail addresses or names. Further, if the data is sorted by one of the columns, that column will be super-compressible (for example, runs of the same value can be run-length encoded).

But of course, the above observation only immediately affects compression ratio. Disk space is cheap, and is getting cheaper rapidly (of course, reducing the number of needed disks will reduce power consumption, a cost-factor that is becoming increasingly important). However, compression improves performance (in addition to reducing disk space) since if data is compressed, then less time must be spent in I/O as data is read from disk into memory (or from memory to CPU). Consequently, some of the “heavier-weight” compression schemes that optimize for compression ratio (such as Lempel-Ziv, Huffman, or arithmetic encoding), might be less suitable than “lighter-weight” schemes that sacrifice compression ratio for decompression performance [4, 26]. In fact, compression can improve query performance beyond simply saving on I/O. **If a column-oriented query executor can operate directly on compressed data, decompression can be avoided completely and performance can be further improved.** For example, for schemes like run-length encoding – where a sequence of repeated values is replaced by a count and the value (e.g., 1 1 1 2 2 1×3 2 $\times 2$) – operating directly on compressed data results in the ability of a query executor to perform the same operation on multiple column values at once, further reducing CPU costs.

Prior work [4] concludes that the biggest difference between

compression in a row-store and compression in a column-store are the cases where a column is sorted (or secondarily sorted) and there are consecutive repeats of the same value in a column. In a column-store, it is extremely easy to summarize these value repeats and operate directly on this summary. In a row-store, the surrounding data from other attributes significantly complicates this process. Thus, in general, compression will have a larger impact on query performance if a high percentage of the columns accessed by that query have some level of order. For the benchmark we use in this paper, we do not store multiple copies of the fact table in different sort orders, and so only one of the seventeen columns in the fact table can be sorted (and two others secondarily sorted) so we expect compression to have a somewhat smaller (and more variable per query) effect on performance than it could if more aggressive redundancy was used.

5.2 Late Materialization

In a column-store, information about a logical entity (e.g., a person) is stored in multiple locations on disk (e.g. name, e-mail address, phone number, etc. are all stored in separate columns), whereas in a row store such information is usually co-located in a single row of a table. However, most queries access more than one attribute from a particular entity. Further, most database output standards (e.g., ODBC and JDBC) access database results entity-at-a-time (not column-at-a-time). Thus, at some point in most query plans, data from multiple columns must be combined together into ‘rows’ of information about an entity. Consequently, this join-like materialization of tuples (also called “tuple construction”) is an extremely common operation in a column store.

Naive column-stores [13, 14] store data on disk (or in memory) column-by-column, read in (to CPU from disk or memory) only those columns relevant for a particular query, construct tuples from their component attributes, and execute normal row-store operators on these rows to process (e.g., select, aggregate, and join) data. Although likely to still outperform the row-stores on data warehouse workloads, this method of constructing tuples early in a query plan (“early materialization”) leaves much of the performance potential of column-oriented databases unrealized.

More recent column-stores such as X100, C-Store, and to a lesser extent, Sybase IQ, choose to keep data in columns until much later into the query plan, operating directly on these columns. In order to do so, intermediate “position” lists often need to be constructed in order to match up operations that have been performed on different columns. Take, for example, a query that applies a predicate on two columns and projects a third attribute from all tuples that pass the predicates. In a column-store that uses late materialization, the predicates are applied to the column for each attribute separately and a list of positions (ordinal offsets within a column) of values that passed the predicates are produced. Depending on the predicate selectivity, this list of positions can be represented as a simple array, a bit string (where a 1 in the *i*th bit indicates that the *i*th value passed the predicate) or as a set of ranges of positions. These position representations are then intersected (if they are bit-strings, bit-wise AND operations can be used) to create a single position list. This list is then sent to the third column to extract values at the desired positions.

The advantages of late materialization are four-fold. First, selection and aggregation operators tend to render the construction of some tuples unnecessary (if the executor waits long enough before constructing a tuple, it might be able to avoid constructing it altogether). Second, if data is compressed using a column-oriented compression method, it must be decompressed before the combination of values with values from other columns. This removes

the advantages of operating directly on compressed data described above. Third, cache performance is improved when operating directly on column data, since a given cache line is not polluted with surrounding irrelevant attributes for a given operation (as shown in PAX [6]). Fourth, the block iteration optimization described in the next subsection has a higher impact on performance for fixed-length attributes. In a row-store, if any attribute in a tuple is variable-width, then the entire tuple is variable width. In a late materialized column-store, fixed-width columns can be operated on separately.

5.3 Block Iteration

In order to process a series of tuples, row-stores first iterate through each tuple, and then need to extract the needed attributes from these tuples through a tuple representation interface [11]. In many cases, such as in MySQL, this leads to tuple-at-a-time processing, where there are 1-2 function calls to extract needed data from a tuple for each operation (which if it is a small expression or predicate evaluation is low cost compared with the function calls) [25].

Recent work has shown that some of the per-tuple overhead of tuple processing can be reduced in row-stores if blocks of tuples are available at once and operated on in a single operator call [24, 15], and this is implemented in IBM DB2 [20]. In contrast to the case-by-case implementation in row-stores, in all column-stores (that we are aware of), blocks of values from the same column are sent to an operator in a single function call. Further, no attribute extraction is needed, and if the column is fixed-width, these values can be iterated through directly as an array. Operating on data as an array not only minimizes per-tuple overhead, but it also exploits potential for parallelism on modern CPUs, as loop-pipelining techniques can be used [9].

5.4 Invisible Join

Queries over data warehouses, particularly over data warehouses modeled with a star schema, often have the following structure: Restrict the set of tuples in the fact table using selection predicates on one (or many) dimension tables. Then, perform some aggregation on the restricted fact table, often grouping by other dimension table attributes. Thus, joins between the fact table and dimension tables need to be performed for each selection predicate and for each aggregate grouping. A good example of this is Query 3.1 from the Star Schema Benchmark.

```
SELECT c.nation, s.nation, d.year,
       sum(lo.revenue) as revenue
FROM customer AS c, lineorder AS lo,
     supplier AS s, dwdate AS d
WHERE lo.custkey = c.custkey
     AND lo.suppkey = s.suppkey
     AND lo.orderdate = d.datekey
     AND c.region = ASIA
     AND s.region = ASIA
     AND d.year >= 1992 and d.year <= 1997
GROUP BY c.nation, s.nation, d.year
ORDER BY d.year asc, revenue desc;
```

This query finds the total revenue from customers who live in Asia and who purchase a product supplied by an Asian supplier between the years 1992 and 1997 grouped by each unique combination of the nation of the customer, the nation of the supplier, and the year of the transaction.

The traditional plan for executing these types of queries is to pipeline joins in order of predicate selectivity. For example, if `c.region = ASIA` is the most selective predicate, the join on `custkey` between the `lineorder` and `customer` tables is

performed first, filtering the `lineorder` table so that only orders from customers who live in Asia remain. As this join is performed, the `nation` of these customers are added to the joined `customer-order` table. These results are pipelined into a join with the `supplier` table where the `s.region = ASIA` predicate is applied and `s.nation` extracted, followed by a join with the data table and the `year` predicate applied. The results of these joins are then grouped and aggregated and the results sorted according to the `ORDER BY` clause.

An alternative to the traditional plan is the late materialized join technique [5]. In this case, a predicate is applied on the `c.region` column (`c.region = ASIA`), and the customer key of the customer table is extracted at the positions that matched this predicate. These keys are then joined with the customer key column from the fact table. The results of this join are two sets of positions, one for the fact table and one for the dimension table, indicating which pairs of tuples from the respective tables passed the join predicate and are joined. In general, at most one of these two position lists are produced in sorted order (the outer table in the join, typically the fact table). Values from the `c.nation` column at this (out-of-order) set of positions are then extracted, along with values (using the ordered set of positions) from the other fact table columns (supplier key, order date, and revenue). Similar joins are then performed with the supplier and date tables.

Each of these plans have a set of disadvantages. In the first (traditional) case, constructing tuples before the join precludes all of the late materialization benefits described in Section 5.2. In the second case, values from dimension table group-by columns need to be extracted in out-of-position order, which can have significant cost [5].

As an alternative to these query plans, we introduce a technique we call the *invisible join* that can be used in column-oriented databases for foreign-key/primary-key joins on star schema style tables. It is a late materialized join, but minimizes the values that need to be extracted out-of-order, thus alleviating both sets of disadvantages described above. It works by rewriting joins into predicates on the foreign key columns in the fact table. These predicates can be evaluated either by using a hash lookup (in which case a hash join is simulated), or by using more advanced methods, such as a technique we call *between-predicate rewriting*, discussed in Section 5.4.2 below.

By rewriting the joins as selection predicates on fact table columns, they can be executed at the same time as other selection predicates that are being applied to the fact table, and any of the predicate application algorithms described in previous work [5] can be used. For example, each predicate can be applied in parallel and the results merged together using fast bitmap operations. Alternatively, the results of a predicate application can be pipelined into another predicate application to reduce the number of times the second predicate must be applied. Only after all predicates have been applied are the appropriate tuples extracted from the relevant dimensions (this can also be done in parallel). By waiting until all predicates have been applied before doing this extraction, the number of out-of-order extractions is minimized.

The invisible join extends previous work on improving performance for star schema joins [17, 23] that are reminiscent of semi-joins [8] by taking advantage of the column-oriented layout, and rewriting predicates to avoid hash-lookups, as described below.

5.4.1 Join Details

The invisible join performs joins in three phases. First, each predicate is applied to the appropriate dimension table to extract a list of dimension table keys that satisfy the predicate. These keys

are used to build a hash table that can be used to test whether a particular key value satisfies the predicate (the hash table should easily fit in memory since dimension tables are typically small and the table contains only keys). An example of the execution of this first phase for the above query on some sample data is displayed in Figure 2.

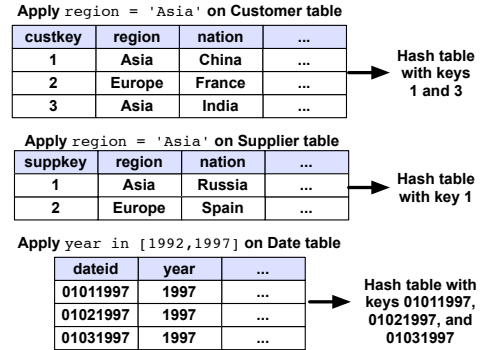

Figure 2: The first phase of the joins needed to execute Query 3.1 from the Star Schema benchmark on some sample data

In the next phase, each hash table is used to extract the positions of records in the fact table that satisfy the corresponding predicate. This is done by probing into the hash table with each value in the foreign key column of the fact table, creating a list of all the positions in the foreign key column that satisfy the predicate. Then, the position lists from all of the predicates are intersected to generate a list of satisfying positions P in the fact table. An example of the execution of this second phase is displayed in Figure 3. Note that a position list may be an explicit list of positions, or a bitmap as shown in the example.

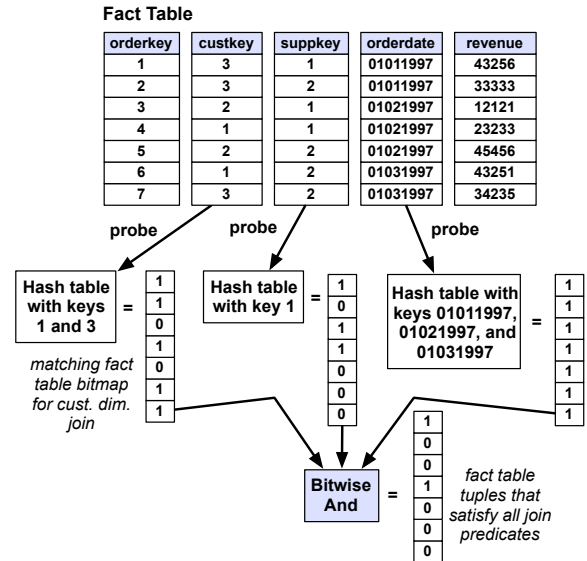

Figure 3: The second phase of the joins needed to execute Query 3.1 from the Star Schema benchmark on some sample data

The third phase of the join uses the list of satisfying positions P in the fact table. For each column C in the fact table containing a foreign key reference to a dimension table that is needed to answer

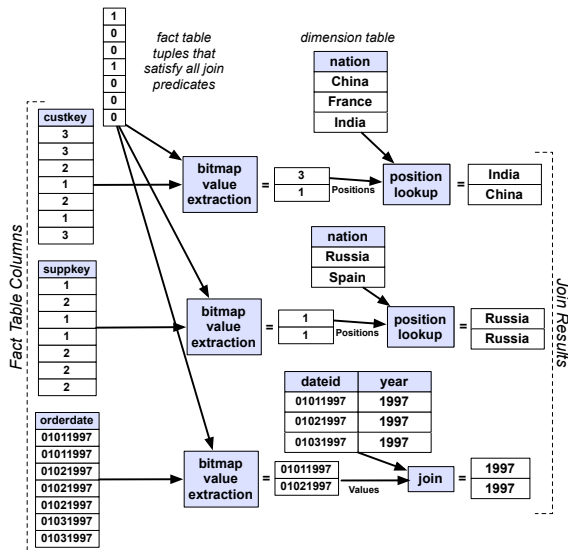

Figure 4: The third phase of the joins needed to execute Query 3.1 from the Star Schema benchmark on some sample data

the query (e.g., where the dimension column is referenced in the select list, group by, or aggregate clauses), foreign key values from C are extracted using P and are looked up in the corresponding dimension table. Note that if the dimension table key is a sorted, contiguous list of identifiers starting from 1 (which is the common case), then the foreign key actually represents the position of the desired tuple in dimension table. This means that the needed dimension table columns can be extracted directly using this position list (and this is simply a fast array look-up).

This direct array extraction is the reason (along with the fact that dimension tables are typically small so the column being looked up can often fit inside the L2 cache) why this join does not suffer from the above described pitfalls of previously published late materialized join approaches [5] where this final position list extraction is very expensive due to the out-of-order nature of the dimension table value extraction. Further, the number values that need to be extracted is minimized since the number of positions in P is dependent on the selectivity of the entire query, instead of the selectivity of just the part of the query that has been executed so far.

An example of the execution of this third phase is displayed in Figure 4. Note that for the date table, the key column is not a sorted, contiguous list of identifiers starting from 1, so a full join must be performed (rather than just a position extraction). Further, note that since this is a foreign-key primary-key join, and since all predicates have already been applied, there is guaranteed to be one and only one result in each dimension table for each position in the intersected position list from the fact table. This means that there are the same number of results for each dimension table join from this third phase, so each join can be done separately and the results combined (stitched together) at a later point in the query plan.

5.4.2 Between-Predicate Rewriting

As described thus far, this algorithm is not much more than another way of thinking about a column-oriented semijoin or a late materialized hash join. Even though the hash part of the join is expressed as a predicate on a fact table column, practically there is little difference between the way the predicate is applied and the way a (late materialization) hash join is executed. The advantage

of expressing the join as a predicate comes into play in the surprisingly common case (for star schema joins) where the set of keys in dimension table that remain after a predicate has been applied are contiguous. When this is the case, a technique we call “between-predicate rewriting” can be used, where the predicate can be rewritten from a hash-lookup predicate on the fact table to a “between” predicate where the foreign key falls between two ends of the key range. For example, if the contiguous set of keys that are valid after a predicate has been applied are keys 1000-2000, then instead of inserting each of these keys into a hash table and probing the hash table for each foreign key value in the fact table, we can simply check to see if the foreign key is in between 1000 and 2000. If so, then the tuple joins; otherwise it does not. Between-predicates are faster to execute for obvious reasons as they can be evaluated directly without looking anything up.

The ability to apply this optimization hinges on the set of these valid dimension table keys being contiguous. In many instances, this property does not hold. For example, a range predicate on a non-sorted field results in non-contiguous result positions. And even for predicates on sorted fields, the process of sorting the dimension table by that attribute likely reordered the primary keys so they are no longer an ordered, contiguous set of identifiers. However, the latter concern can be easily alleviated through the use of dictionary encoding for the purpose of key reassignment (rather than compression). Since the keys are unique, dictionary encoding the column results in the dictionary keys being an ordered, contiguous list starting from 0. As long as the fact table foreign key column is encoded using the same dictionary table, the hash-table to between-predicate rewriting can be performed.

Further, the assertion that the optimization works only on predicates on the sorted column of a dimension table is not entirely true. In fact, dimension tables in data warehouses often contain sets of attributes of increasingly finer granularity. For example, the date table in SSBM has a year column, a yearmonth column, and the complete date column. If the table is sorted by year, secondarily sorted by yearmonth, and tertiarily sorted by the complete date, then equality predicates on any of those three columns will result in a contiguous set of results (or a range predicate on the sorted column). As another example, the supplier table has a region column, a nation column, and a city column (a region has many nations and a nation has many cities). Again, sorting from left-to-right will result in predicates on any of those three columns producing a contiguous range output. Data warehouse queries often access these columns, due to the OLAP practice of rolling-up data in successive queries (tell me profit by region, tell me profit by nation, tell me profit by city). Thus, “between-predicate rewriting” can be used more often than one might initially expect, and (as we show in the next section), often yields a significant performance gain.

Note that predicate rewriting does not require changes to the query optimizer to detect when this optimization can be used. The code that evaluates predicates against the dimension table is capable of detecting whether the result set is contiguous. If so, the fact table predicate is rewritten at run-time.

6. EXPERIMENTS

In this section, we compare the row-oriented approaches to the performance of C-Store on the SSBM, with the goal of answering four key questions:

1. How do the different attempts to emulate a column store in a row-store compare to the baseline performance of C-Store?

2. Is it possible for an unmodified row-store to obtain the benefits of column-oriented design?
3. Of the specific optimizations proposed for column-stores (compression, late materialization, and block processing), which are the most significant?
4. How does the cost of performing star schema joins in column-stores using the invisible join technique compare with executing queries on a denormalized fact table where the join has been pre-executed?

By answering these questions, we provide database implementers who are interested in adopting a column-oriented approach with guidelines for which performance optimizations will be most fruitful. Further, the answers will help us understand what changes need to be made at the storage-manager and query executor levels to row-stores if row-stores are to successfully simulate column-stores.

All of our experiments were run on a 2.8 GHz single processor, dual core Pentium(R) D workstation with 3 GB of RAM running RedHat Enterprise Linux 5. The machine has a 4-disk array, managed as a single logical volume with files striped across it. Typical I/O throughput is 40 - 50 MB/sec/disk, or 160 - 200 MB/sec in aggregate for striped files. The numbers we report are the average of several runs, and are based on a “warm” buffer pool (in practice, we found that this yielded about a 30% performance increase for both systems; the gain is not particularly dramatic because the amount of data read by each query exceeds the size of the buffer pool).

6.1 Motivation for Experimental Setup

Figure 5 compares the performance of C-Store and System X on the Star Schema Benchmark. We caution the reader to not read too much into absolute performance differences between the two systems — as we discuss in this section, there are substantial differences in the implementations of these systems beyond the basic difference of rows vs. columns that affect these performance numbers.

In this figure, “RS” refers to numbers for the base System X case, “CS” refers to numbers for the base C-Store case, and “RS (MV)” refers to numbers on System X using an optimal collection of materialized views containing minimal projections of tables needed to answer each query (see Section 4). As shown, C-Store outperforms System X by a factor of six in the base case, and a factor of three when System X is using materialized views. This is consistent with previous work that shows that column-stores can significantly outperform row-stores on data warehouse workloads [2, 9, 22].

However, the fourth set of numbers presented in Figure 5, “CS (Row-MV)” illustrate the caution that needs to be taken when comparing numbers across systems. For these numbers, we stored the identical (row-oriented!) materialized view data inside C-Store. One might expect the C-Store storage manager to be unable to store data in rows since, after all, it is a column-store. However, this can be done easily by using tables that have a single column of type “string”. The values in this column are entire tuples. One might also expect that the C-Store query executor would be unable to operate on rows, since it expects individual columns as input. However, rows are a legal intermediate representation in C-Store — as explained in Section 5.2, at some point in a query plan, C-Store reconstructs rows from component columns (since the user interface to a RDBMS is row-by-row). After it performs this tuple reconstruction, it proceeds to execute the rest of the query plan using standard row-store operators [5]. Thus, both the “CS (Row-MV)” and the “RS (MV)” are executing the same queries on the same input data stored in the same way. Consequently, one might expect these numbers to be identical.

In contrast with this expectation, the System X numbers are significantly faster (more than a factor of two) than the C-Store numbers. In retrospect, this is not all that surprising — System X has teams of people dedicated to seeking and removing performance bottlenecks in the code, while C-Store has multiple known performance bottlenecks that have yet to be resolved [3]. Moreover, C-Store, as a simple prototype, has not implemented advanced performance features that are available in System X. Two of these features are partitioning and multi-threading. System X is able to partition each materialized view optimally for the query flight that it is designed for. Partitioning improves performance when running on a single machine by reducing the data that needs to be scanned in order to answer a query. For example, the materialized view used for query flight 1 is partitioned on orderdate year, which is useful since each query in this flight has a predicate on orderdate. To determine the performance advantage System X receives from partitioning, we ran the same benchmark on the same materialized views without partitioning them. We found that the average query time in this case was 20.25 seconds. Thus, partitioning gives System X a factor of two advantage (though this varied by query, which will be discussed further in Section 6.2). C-Store is also at a disadvantage since it not multi-threaded, and consequently is unable to take advantage of the extra core.

Thus, there are many differences between the two systems we experiment with in this paper. Some are fundamental differences between column-stores and row-stores, and some are implementation artifacts. Since it is difficult to come to useful conclusions when comparing numbers across different systems, we choose a different tactic in our experimental setup, exploring benchmark performance from two angles. In Section 6.2 we attempt to simulate a column-store inside of a row-store. The experiments in this section are only on System X, and thus we do not run into cross-system comparison problems. In Section 6.3, we remove performance optimizations from C-Store until row-store performance is achieved. Again, all experiments are on only a single system (C-Store).

By performing our experiments in this way, we are able to come to some conclusions about the performance advantage of column-stores without relying on cross-system comparisons. For example, it is interesting to note in Figure 5 that there is more than a factor of six difference between “CS” and “CS (Row MV)” despite the fact that they are run on the same system and both read the minimal set of columns off disk needed to answer each query. Clearly the performance advantage of a column-store is more than just the I/O advantage of reading in less data from disk. We will explain the reason for this performance difference in Section 6.3.

6.2 Column-Store Simulation in a Row-Store

In this section, we describe the performance of the different configurations of System X on the Star Schema Benchmark. We configured System X to partition the `lineorder` table on `orderdate` by year (this means that a different physical partition is created for tuples from each year in the database). As described in Section 6.1, this partitioning substantially speeds up SSBM queries that involve a predicate on `orderdate` (queries 1.1, 1.2, 1.3, 3.4, 4.2, and 4.3 query just 1 year; queries 3.1, 3.2, and 3.3 include a substantially less selective query over half of years). Unfortunately, for the column-oriented representations, System X doesn’t allow us to partition two-column vertical partitions on `orderdate` (since they do not contain the `orderdate` column, except, of course, for the `orderdate` vertical partition), which means that for those query flights that restrict on the `orderdate` column, the column-oriented approaches are at a disadvantage relative to the base case.

Nevertheless, we decided to use partitioning for the base case

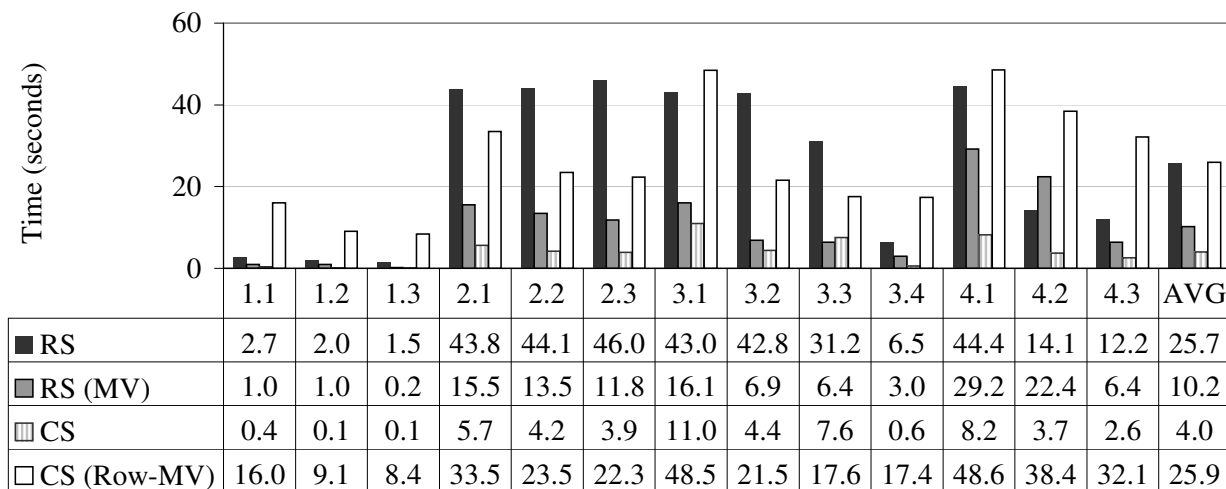

Figure 5: Baseline performance of C-Store “CS” and System X “RS”, compared with materialized view cases on the same systems.

because it is in fact the strategy that a database administrator would use when trying to improve the performance of these queries on a row-store. When we ran the base case without partitioning, performance was reduced by a factor of two on average (though this varied per query depending on the selectivity of the predicate on the `orderdate` column). Thus, we would expect the vertical partitioning case to improve by a factor of two, on average, if it were possible to partition tables based on two levels of indirection (from primary key, or `record-id`, we get `orderdate`, and from `orderdate` we get `year`).

Other relevant configuration parameters for System X include: 32 KB disk pages, a 1.5 GB maximum memory for sorts, joins, intermediate results, and a 500 MB buffer pool. We experimented with different buffer pool sizes and found that different sizes did not yield large differences in query times (due to dominant use of large table scans in this benchmark), unless a very small buffer pool was used. We enabled compression and sequential scan prefetching, and we noticed that both of these techniques improved performance, again due to the large amount of I/O needed to process these queries. System X also implements a star join and the optimizer will use bloom filters when it expects this will improve query performance.

Recall from Section 4 that we experimented with six configurations of System X on SSBM:

1. A “traditional” row-oriented representation; here, we allow System X to use bitmaps and bloom filters if they are beneficial.
2. A “traditional (bitmap)” approach, similar to traditional, but with plans biased to use bitmaps, sometimes causing them to produce inferior plans to the pure traditional approach.
3. A “vertical partitioning” approach, with each column in its own relation with the record-id from the original relation.
4. An “index-only” representation, using an unclustered B+tree on each column in the row-oriented approach, and then answering queries by reading values directly from the indexes.
5. A “materialized views” approach with the optimal collection of materialized views for every query (no joins were performed in advance in these views).

The detailed results broken down by query flight are shown in Figure 6(a), with average results across all queries shown in Fig-

ure 6(b). Materialized views perform best in all cases, because they read the minimal amount of data required to process a query. After materialized views, the traditional approach or the traditional approach with bitmap indexing, is usually the best choice. On average, the traditional approach is about three times better than the best of our attempts to emulate a column-oriented approach. This is particularly true of queries that can exploit partitioning on `orderdate`, as discussed above. For query flight 2 (which does not benefit from partitioning), the vertical partitioning approach is competitive with the traditional approach; the index-only approach performs poorly for reasons we discuss below. Before looking at the performance of individual queries in more detail, we summarize the two high level issues that limit the approach of the columnar approaches: tuple overheads, and inefficient tuple reconstruction:

Tuple overheads: As others have observed [16], one of the problems with a fully vertically partitioned approach in a row-store is that tuple overheads can be quite large. This is further aggravated by the requirement that record-ids or primary keys be stored with each column to allow tuples to be reconstructed. We compared the sizes of column-tables in our vertical partitioning approach to the sizes of the traditional row store tables, and found that a single column-table from our SSBM scale 10 `lineorder` table (with 60 million tuples) requires between 0.7 and 1.1 GBytes of data after compression to store – this represents about 8 bytes of overhead per row, plus about 4 bytes each for the record-id and the column attribute, depending on the column and the extent to which compression is effective ($16 \text{ bytes} \times 6 \times 10^7 \text{ tuples} = 960 \text{ MB}$). In contrast, the entire 17 column `lineorder` table in the traditional approach occupies about 6 GBytes decompressed, or 4 GBytes compressed, meaning that scanning just four of the columns in the vertical partitioning approach will take as long as scanning the entire fact table in the traditional approach. As a point of comparison, in C-Store, a single column of integers takes just 240 MB ($4 \text{ bytes} \times 6 \times 10^7 \text{ tuples} = 240 \text{ MB}$), and the entire table compressed takes 2.3 Gbytes.

Column Joins: As we mentioned above, merging two columns from the same table together requires a join operation. System X favors using hash-joins for these operations. We experimented with forcing System X to use index nested loops and merge joins, but found that this did not improve performance because index accesses had high overhead and System X was unable to skip the sort preceding the merge join.

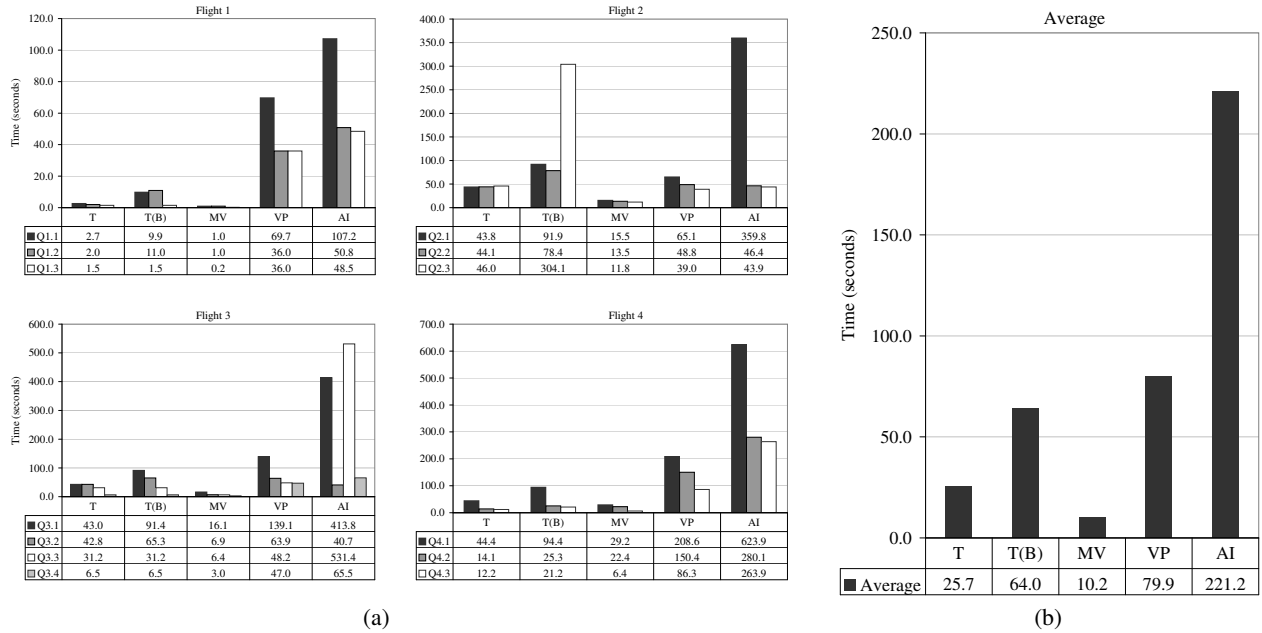

Figure 6: (a) Performance numbers for different variants of the row-store by query flight. Here, T is traditional, T(B) is traditional (bitmap), MV is materialized views, VP is vertical partitioning, and AI is all indexes. (b) Average performance across all queries.

6.2.1 Detailed Row-store Performance Breakdown

In this section, we look at the performance of the row-store approaches, using the plans generated by System X for query 2.1 from the SSBM as a guide (we chose this query because it is one of the few that does not benefit from `orderdate` partitioning, so provides a more equal comparison between the traditional and vertical partitioning approach.) Though we do not dissect plans for other queries as carefully, their basic structure is the same. The SQL for this query is:

```
SELECT sum(lo.revenue), d.year, p.brand1
FROM lineorder AS lo, ddate AS d,
     part AS p, supplier AS s
WHERE lo.orderdate = d.datekey
      AND lo.partkey = p.partkey
      AND lo.supkey = s.supkey
      AND p.category = MFGR#12
      AND s.region = AMERICA
GROUP BY d.year, p.brand1
ORDER BY d.year, p.brand1
```

The selectivity of this query is 8.0×10^{-3} . Here, the vertical partitioning approach performs about as well as the traditional approach (65 seconds versus 43 seconds), but the index-only approach performs substantially worse (360 seconds). We look at the reasons for this below.

Traditional: For this query, the traditional approach scans the entire `lineorder` table, using hash joins to join it with the `ddate`, `part`, and `supplier` table (in that order). It then performs a sort-based aggregate to compute the final answer. The cost is dominated by the time to scan the `lineorder` table, which in our system requires about 40 seconds. Materialized views take just 15 seconds, because they have to read about 1/3rd of the data as the traditional approach.

Vertical partitioning: The vertical partitioning approach hash-joins the `partkey` column with the filtered `part` table, and the

`supkey` column with the filtered `supplier` table, and then hash-joins these two result sets. This yields tuples with the record-id from the fact table and the `p.brand1` attribute of the `part` table that satisfy the query. System X then hash joins this with the `ddate` table to pick up `d.year`, and finally uses an additional hash join to pick up the `lo.revenue` column from its column table. This approach requires four columns of the `lineorder` table to be read in their entirety (sequentially), which, as we said above, requires about as many bytes to be read from disk as the traditional approach, and this scan cost dominates the runtime of this query, yielding comparable performance as compared to the traditional approach. Hash joins in this case slow down performance by about 25%; we experimented with eliminating the hash joins by adding clustered B+trees on the key columns in each vertical partition, but System X still chose to use hash joins in this case.

Index-only plans: Index-only plans access all columns through unclustered B+Tree indexes, joining columns from the same table on record-id (so they never follow pointers back to the base relation). The plan for query 2.1 does a full index scan on the `supkey`, `revenue`, `partkey`, and `orderdate` columns of the fact table, joining them in that order with hash joins. In this case, the index scans are relatively fast sequential scans of the entire index file, and do not require seeks between leaf pages. The hash joins, however, are quite slow, as they combine two 60 million tuple columns each of which occupies hundreds of megabytes of space. Note that hash join is probably the best option for these joins, as the output of the index scans is not sorted on record-id, and sorting record-id lists or performing index-nested loops is likely to be *much* slower. As we discuss below, we couldn't find a way to force System X to defer these joins until later in the plan, which would have made the performance of this approach closer to vertical partitioning.

After joining the columns of the fact table, the plan uses an index range scan to extract the filtered `part.category` column and hash joins it with the `part.brand1` column and the `part.part-`

key column (both accessed via full index scans). It then hash joins this result with the already joined columns of the fact table. Next, it hash joins `supplier.region` (filtered through an index range scan) and the `supplier.supkey` columns (accessed via full index scan), and hash joins that with the fact table. Finally, it uses full index scans to access the `dwdate.datekey` and `dwdate.year` columns, joins them using hash join, and hash joins the result with the fact table.

6.2.2 Discussion

The previous results show that none of our attempts to emulate a column-store in a row-store are particularly effective. The vertical partitioning approach can provide performance that is competitive with or slightly better than a row-store when selecting just a few columns. When selecting more than about 1/4 of the columns, however, the wasted space due to tuple headers and redundant copies of the record-id yield inferior performance to the traditional approach. This approach also requires relatively expensive hash joins to combine columns from the fact table together. It is possible that System X could be tricked into storing the columns on disk in sorted order and then using a merge join (without a sort) to combine columns from the fact table but our DBA was unable to coax this behavior from the system.

Index-only plans have a lower per-record overhead, but introduce another problem – namely, the system is forced to join columns of the fact table together using expensive hash joins before filtering the fact table using dimension columns. It appears that System X is unable to defer these joins until later in the plan (as the vertical partitioning approach does) because it cannot retain record-ids from the fact table after it has joined with another table. These giant hash joins lead to extremely slow performance.

With respect to the traditional plans, materialized views are an obvious win as they allow System X to read just the subset of the fact table that is relevant, without merging columns together. Bitmap indices sometimes help – especially when the selectivity of queries is low – because they allow the system to skip over some pages of the fact table when scanning it. In other cases, they slow the system down as merging bitmaps adds some overhead to plan execution and bitmap scans can be slower than pure sequential scans.

As a final note, we observe that implementing these plans in System X was quite painful. We were required to rewrite all of our queries to use the vertical partitioning approaches, and had to make extensive use of optimizer hints and other trickery to coax the system into doing what we desired.

In the next section we study how a column-store system designed from the ground up is able to circumvent these limitations, and break down the performance advantages of the different features of the C-Store system on the SSBM benchmark.

6.3 Column-Store Performance

It is immediately apparent upon the inspection of the average query time in C-Store on the SSBM (around 4 seconds) that it is faster than not only the simulated column-oriented stores in the row-store (80 seconds to 220 seconds), but even faster than the best-case scenario for the row-store where the queries are known in advance and the row-store has created materialized views tailored for the query plans (10.2 seconds). Part of this performance difference can be immediately explained without further experiments – column-stores do not suffer from the tuple overhead and high column join costs that row-stores do (this will be explained in Section 6.3.1). However, this observation does not explain the reason why the column-store is faster than the materialized view case or

the “CS Row-MV” case from Section 6.1, where the amount of I/O across systems is similar, and the other systems does not need join together columns from the same table. In order to understand this latter performance difference, we perform additional experiments in the column-store where we successively remove column-oriented optimizations until the column-store begins to simulate a row-store. In so doing, we learn the impact of these various optimizations on query performance. These results are presented in Section 6.3.2.

6.3.1 Tuple Overhead and Join Costs

Modern column-stores do not explicitly store the record-id (or primary key) needed to join together columns from the same table. Rather, they use implicit column positions to reconstruct columns (the i th value from each column belongs to the i th tuple in the table). Further, tuple headers are stored in their own separate columns and so they can be accessed separately from the actual column values. Consequently, a column in a column-store contains just data from that column, rather than a tuple header, a record-id, and column data in a vertically partitioned row-store.

In a column-store, heap files are stored in position order (the i th value is always after the $i - 1$ st value), whereas the order of heap files in many row-stores, even on a clustered attribute, is only guaranteed through an index. This makes a merge join (without a sort) the obvious choice for tuple reconstruction in a column-store. In a row-store, since iterating through a sorted file must be done indirectly through the index, which can result in extra seeks between index leaves, an index-based merge join is a slow way to reconstruct tuples.

It should be noted that neither of the above differences between column-store performance and row-store performance are fundamental. There is no reason why a row-store cannot store tuple headers separately, use virtual record-ids to join data, and maintain heap files in guaranteed position order. The above observation simply highlights some important design considerations that would be relevant if one wanted to build a row-store that can successfully simulate a column-store.

6.3.2 Breakdown of Column-Store Advantages

As described in Section 5, three column-oriented optimizations, presented separately in the literature, all claim to significantly improve the performance of column-oriented databases. These optimizations are compression, late materialization, and block-iteration. Further, we extended C-Store with the invisible join technique which we also expect will improve performance. Presumably, these optimizations are the reason for the performance difference between the column-store and the row-oriented materialized view cases from Figure 5 (both in System X and in C-Store) that have similar I/O patterns as the column-store. In order to verify this presumption, we successively removed these optimizations from C-Store and measured performance after each step.

Removing compression from C-Store was simple since C-Store includes a runtime flag for doing so. Removing the invisible join was also simple since it was a new operator we added ourselves. In order to remove late materialization, we had to hand code query plans to construct tuples at the beginning of the query plan. Removing block-iteration was somewhat more difficult than the other three optimizations. C-Store “blocks” of data can be accessed through two interfaces: “getNext” and “asArray”. The former method requires one function call per value iterated through, while the latter method returns a pointer to an array that can be iterated through directly. For the operators used in the SSBM query plans that access blocks through the “asArray” interface, we wrote alternative ver-

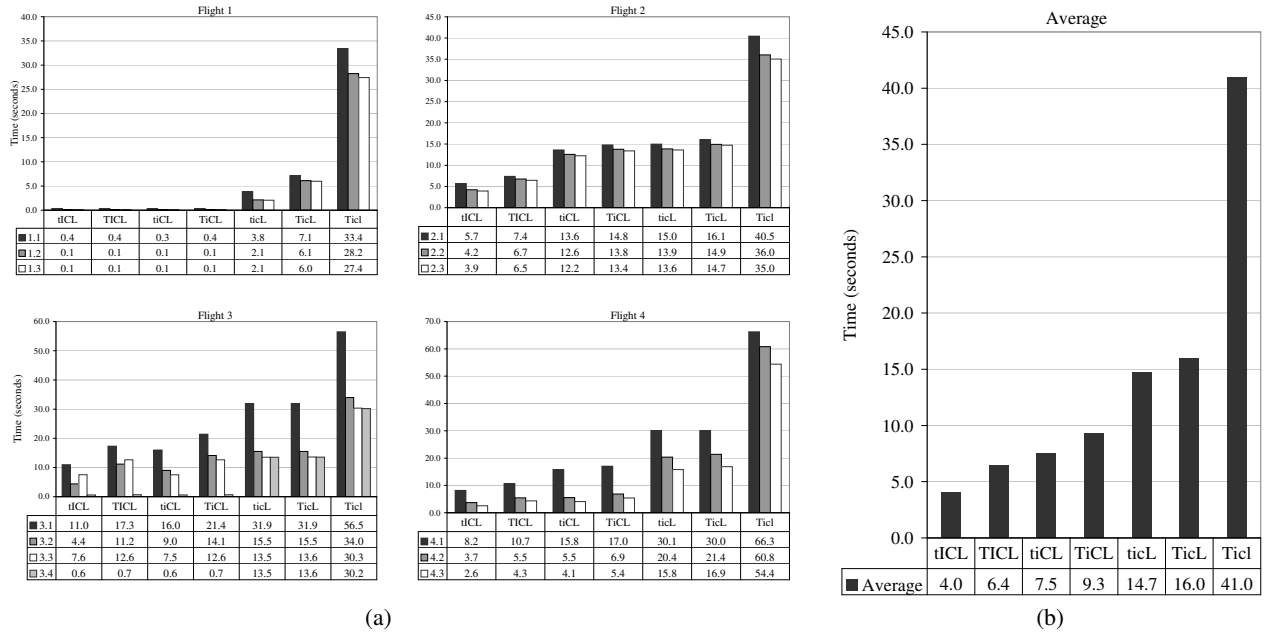

Figure 7: (a) Performance numbers for C-Store by query flight with various optimizations removed. The four letter code indicates the C-Store configuration: T=tuple-at-a-time processing, t=block processing; I=invisible join enabled, i=disabled; C=compression enabled, c=disabled; L=late materialization enabled, l=disabled. (b) Average performance numbers for C-Store across all queries.

sions that use “getNext”. We only noticed a significant difference in the performance of selection operations using this method.

Figure 7(a) shows detailed, per-query results of successively removing these optimizations from C-Store, with averages across all SSBM queries shown in Figure 7(b). Block-processing can improve performance anywhere from a factor of only 5% to 50% depending on whether compression has already been removed (when compression is removed, the CPU benefits of block processing is not as significant since I/O becomes a factor). In other systems, such as MonetDB/X100, that are more carefully optimized for block-processing [9], one might expect to see a larger performance degradation if this optimization were removed.

The invisible join improves performance by 50-75%. Since C-Store uses the similar “late-materialized join” technique in the absence of the invisible join, this performance difference is largely due to the between-predicate rewriting optimization. There are many cases in the SSBM where the between-predicate rewriting optimization can be used. In the supplier table, the region, nation, and city columns are attributes of increasingly finer granularity, which, as described in Section 5.4, result in contiguous positional result sets from equality predicate application on any of these columns. The customer table has a similar region, nation, and city column trio. The part table has mfg, category, and brand as attributes of increasingly finer granularity. Finally, the date table has year, month, and day increasing in granularity. Every query in the SSBM contain one or more joins (all but the first query flight contains more than one join), and for each query, at least one of the joins is with a dimension table that had a predicate on one of these special types of attributes. Hence, it was possible to use the between-predicate rewriting optimization at least once per query.

Clearly, the most significant two optimizations are compression and late materialization. Compression improves performance by almost a factor of two on average. However, as mentioned in Section 5, we do not redundantly store the fact table in multiple sort

orders to get the full advantage of compression (only one column – the orderdate column – is sorted, and two others secondarily sorted – the quantity and discount columns). The columns in the fact table that are accessed by the SSBM queries are not very compressible if they do not have order to them, since they are either keys (which have high cardinality) or are random values. The first query flight, which accesses each of the three columns that have order to them, demonstrates the performance benefits of compression when queries access highly compressible data. In this case, compression results in an order of magnitude performance improvement. This is because runs of values in the three ordered columns can be run-length encoded (RLE). Not only does run-length encoding yield a good compression ratio and thus reduced I/O overhead, but RLE is also very simple to operate on directly (for example, a predicate or an aggregation can be applied to an entire run at once). The primary sort column, orderdate, only contains 2405 unique values, and so the average run-length for this column is almost 25,000. This column takes up less than 64K of space.

The other significant optimization is late materialization. This optimization was removed last since data needs to be decompressed in the tuple construction process, and early materialization results in row-oriented execution which precludes invisible joins. Late materialization results in almost a factor of three performance improvement. This is primarily because of the selective predicates in some of the SSBM queries. The more selective the predicate, the more wasteful it is to construct tuples at the start of a query plan, since such are tuples immediately discarded.

Note that once all of these optimizations are removed, the column-store acts like a row-store. Columns are immediately stitched together and after this is done, processing is identical to a row-store. Since this is the case, one would expect the column-store to perform similarly to the row-oriented materialized view cases from Figure 5 (both in System X and in C-Store) since the I/O requirements and the query processing are similar – the only difference

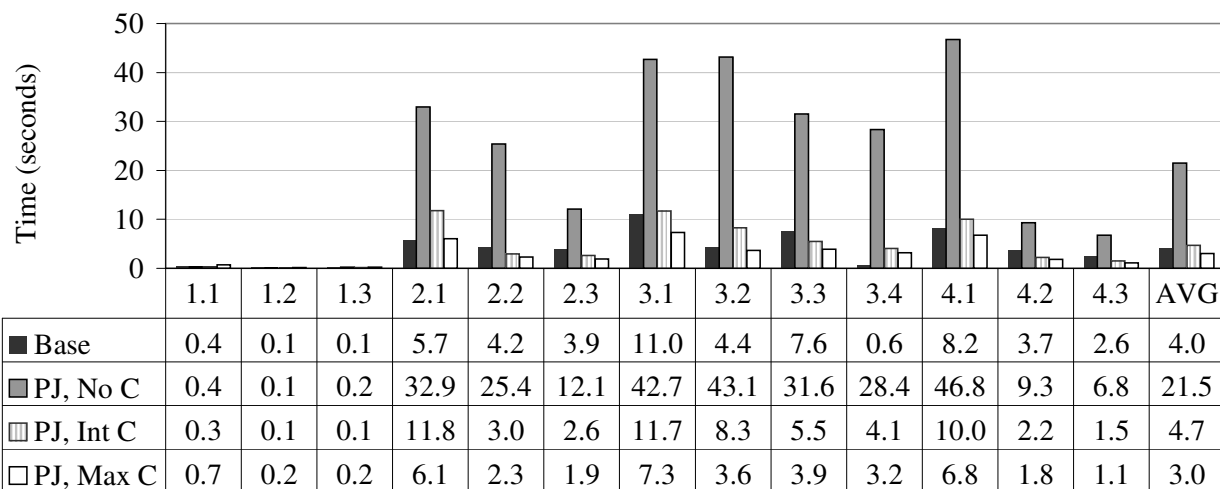

Figure 8: Comparison of performance of baseline C-Store on the original SSBM schema with a denormalized version of the schema. Denormalized columns are either not compressed (“PJ, No C”), dictionary compressed into integers (“PJ, Int C”), or compressed as much as possible (“PJ, Max C”).

is the necessary tuple-construction at the beginning of the query plans for the column store. Section 6.1 cautioned against direct comparisons with System X, but by comparing these numbers with the “CS Row-MV” case from Figure 5, we see how expensive tuple construction can be (it adds almost a factor of 2). This is consistent with previous results [5].

6.3.3 Implications of Join Performance

In profiling the code, we noticed that in the baseline C-Store case, performance is dominated in the lower parts of the query plan (predicate application) and that the invisible join technique made join performance relatively cheap. In order to explore this observation further we created a denormalized version of the fact table where the fact table and its dimension table are pre-joined such that instead of containing a foreign key into the dimension table, the fact table contains all of the values found in the dimension table repeated for each fact table record (e.g., all customer information is contained in each fact table tuple corresponding to a purchase made by that customer). Clearly, this complete denormalization would be more detrimental from a performance perspective in a row-store since this would significantly widen the table. However, in a column-store, one might think this would speed up read-only queries since only those columns relevant for a query need to read in, and joins would be avoided.

Surprisingly, we found this often not to be the case. Figure 8 compares the baseline C-Store performance from the previous section (using the invisible join) with the performance of C-Store on the same benchmark using three versions of the single denormalized table where joins have been performed in advance. In the first case, complete strings like customer region and customer nation are included unmodified in the denormalized table. This case performs a factor of 5 worse than the base case. This is because the invisible join converts predicates on dimension table attributes into predicates on fact table foreign key values. When the table is denormalized, predicate application is performed on the actual string attribute in the fact table. In both cases, this predicate application is the dominant step. However, a predicate on the integer foreign key can be performed faster than a predicate on a string attribute since the integer attribute is smaller.

Of course, the string attributes could have easily been dictionary encoded into integers before denormalization. When we did

this (the “PJ, Int C” case in Figure 8), the performance difference between the baseline and the denormalized cases became much smaller. Nonetheless, for quite a few queries, the baseline case still performed faster. The reasons for this are twofold. First, some SSBM queries have two predicates on the same dimension table. The invisible join technique is able to summarize the result of this double predicate application as a single predicate on the foreign key attribute in the fact table. However, for the denormalized case, the predicate must be completely applied to both columns in the fact table (remember that for data warehouses, fact tables are generally much larger than dimension tables, so predicate applications on the fact table are much more expensive than predicate applications on the dimension tables).

Second, many queries have a predicate on one attribute in a dimension table and group by a different attribute from the same dimension table. For the invisible join, this requires iteration through the foreign key column once to apply the predicate, and again (after all predicates from all tables have been applied and intersected) to extract the group-by attribute. But since C-Store uses pipelined execution, blocks from the foreign key column will still be in memory upon the second access. In the denormalized case, the predicate column and the group-by column are separate columns in the fact table and both must be iterated through, doubling the necessary I/O.

In fact, many of the SSBM dimension table columns that are accessed in the queries have low cardinality, and can be compressed into values that are smaller than the integer foreign keys. When using complete C-Store compression, we found that the denormalization technique was useful more often (shown as the “PJ, Max C” case in Figure 8).

These results have interesting implications. Denormalization has long been used as a technique in database systems to improve query performance, by reducing the number of joins that must be performed at query time. In general, the school of wisdom teaches that denormalization trades query performance for making a table wider, and more redundant (increasing the size of the table on disk and increasing the risk of update anomalies). One might expect that this tradeoff would be more favorable in column-stores (denormalization should be used more often) since one of the disadvantages of denormalization (making the table wider) is not problematic when using a column-oriented layout. However, these results show the exact opposite: denormalization is actually not very use-

ful in column-stores (at least for star schemas). This is because the invisible join performs so well that reducing the number of joins via denormalization provides an insignificant benefit. In fact, denormalization only appears to be useful when the dimension table attributes included in the fact table are sorted (or secondarily sorted) or are otherwise highly compressible.

7. CONCLUSION

In this paper, we compared the performance of C-Store to several variants of a commercial row-store system on the data warehousing benchmark, SSBM. We showed that attempts to emulate the physical layout of a column-store in a row-store via techniques like vertical partitioning and index-only plans do not yield good performance. We attribute this slowness to high tuple reconstruction costs, as well as the high per-tuple overheads in narrow, vertically partitioned tables. We broke down the reasons why a column-store is able to process column-oriented data so effectively, finding that late materialization improves performance by a factor of three, and that compression provides about a factor of two on average, or an order-of-magnitude on queries that access sorted data. We also proposed a new join technique, called invisible joins, that further improves performance by about 50%.

The conclusion of this work is not that simulating a column-store in a row-store is impossible. Rather, it is that this simulation performs poorly on today's row-store systems (our experiments were performed on a very recent product release of System X). A successful column-oriented simulation will require some important system improvements, such as virtual record-ids, reduced tuple overhead, fast merge joins of sorted data, run-length encoding across multiple tuples, and some column-oriented query execution techniques like operating directly on compressed data, block processing, invisible joins, and late materialization. Some of these improvements have been implemented or proposed to be implemented in various different row-stores [12, 13, 20, 24]; however, building a complete row-store that can transform into a column-store on workloads where column-stores perform well is an interesting research problem to pursue.

8. ACKNOWLEDGMENTS

We thank Stavros Harizopoulos for his comments on this paper, and the NSF for funding this research, under grants 0704424 and 0325525.

9. REPEATABILITY ASSESSMENT

All figures containing numbers derived from experiments on the C-Store prototype (Figure 7a, Figure 7b, and Figure 8) have been verified by the SIGMOD repeatability committee. We thank Ioana Manolescu and the repeatability committee for their feedback.

10. REFERENCES

- [1] <http://www.sybase.com/products/informationmanagement/sybaseiq>.
- [2] TPC-H Result Highlights Scale 1000GB. http://www.tpc.org/tpch/results/tpch_result_detail.asp?id=107102903.
- [3] D. J. Abadi. Query execution in column-oriented database systems. MIT PhD Dissertation, 2008. PhD Thesis.
- [4] D. J. Abadi, S. R. Madden, and M. Ferreira. Integrating compression and execution in column-oriented database systems. In *SIGMOD*, pages 671–682, 2006.
- [5] D. J. Abadi, D. S. Myers, D. J. DeWitt, and S. R. Madden. Materialization strategies in a column-oriented DBMS. In *ICDE*, pages 466–475, 2007.
- [6] A. Ailamaki, D. J. DeWitt, M. D. Hill, and M. Skounakis. Weaving relations for cache performance. In *VLDB*, pages 169–180, 2001.
- [7] D. S. Batory. On searching transposed files. *ACM Trans. Database Syst.*, 4(4):531–544, 1979.
- [8] P. A. Bernstein and D.-M. W. Chiu. Using semi-joins to solve relational queries. *J. ACM*, 28(1):25–40, 1981.
- [9] P. Boncz, M. Zukowski, and N. Nes. MonetDB/X100: Hyper-pipelining query execution. In *CIDR*, 2005.
- [10] P. A. Boncz and M. L. Kersten. MIL primitives for querying a fragmented world. *VLDB Journal*, 8(2):101–119, 1999.
- [11] G. Graefe. Volcano - an extensible and parallel query evaluation system. 6:120–135, 1994.
- [12] G. Graefe. Efficient columnar storage in b-trees. *SIGMOD Rec.*, 36(1):3–6, 2007.
- [13] A. Halverson, J. L. Beckmann, J. F. Naughton, and D. J. Dewitt. A Comparison of C-Store and Row-Store in a Common Framework. Technical Report TR1570, University of Wisconsin-Madison, 2006.
- [14] S. Harizopoulos, V. Liang, D. J. Abadi, and S. R. Madden. Performance tradeoffs in read-optimized databases. In *VLDB*, pages 487–498, 2006.
- [15] S. Harizopoulos, V. Shkapenyuk, and A. Ailamaki. QPipe: a simultaneously pipelined relational query engine. In *SIGMOD*, pages 383–394, 2005.
- [16] S. Khoshafian, G. Copeland, T. Jagodis, H. Boral, and P. Valduriez. A query processing strategy for the decomposed storage model. In *ICDE*, pages 636–643, 1987.
- [17] P. O'Neil and G. Graefe. Multi-table joins through bitmapped join indices. *SIGMOD Rec.*, 24(3):8–11, 1995.
- [18] P. E. O'Neil, X. Chen, and E. J. O'Neil. Adjoined Dimension Column Index (ADC Index) to Improve Star Schema Query Performance. In *ICDE*, 2008.
- [19] P. E. O'Neil, E. J. O'Neil, and X. Chen. The Star Schema Benchmark (SSB). <http://www.cs.umb.edu/~poneil/StarSchemaB.PDF>.
- [20] S. Padmanabhan, T. Malkemus, R. Agarwal, and A. Jhingran. Block oriented processing of relational database operations in modern computer architectures. In *ICDE*, 2001.
- [21] R. Ramamurthy, D. Dewitt, and Q. Su. A case for fractured mirrors. In *VLDB*, pages 89 – 101, 2002.
- [22] M. Stonebraker, D. J. Abadi, A. Batkin, X. Chen, M. Cherniack, M. Ferreira, E. Lau, A. Lin, S. R. Madden, E. J. O'Neil, P. E. O'Neil, A. Rasin, N. Tran, and S. B. Zdonik. C-Store: A Column-Oriented DBMS. In *VLDB*, pages 553–564, 2005.
- [23] A. Weininger. Efficient execution of joins in a star schema. In *SIGMOD*, pages 542–545, 2002.
- [24] J. Zhou and K. A. Ross. Buffering database operations for enhanced instruction cache performance. In *SIGMOD*, pages 191–202, 2004.
- [25] M. Zukowski, P. A. Boncz, N. Nes, and S. Heman. MonetDB/X100 - A DBMS In The CPU Cache. *IEEE Data Engineering Bulletin*, 28(2):17–22, June 2005.
- [26] M. Zukowski, S. Heman, N. Nes, and P. Boncz. Super-Scalar RAM-CPU Cache Compression. In *ICDE*, 2006.